

Diamond and teardrop patterned steel sheets

Chapas estriadas y lagrimadas

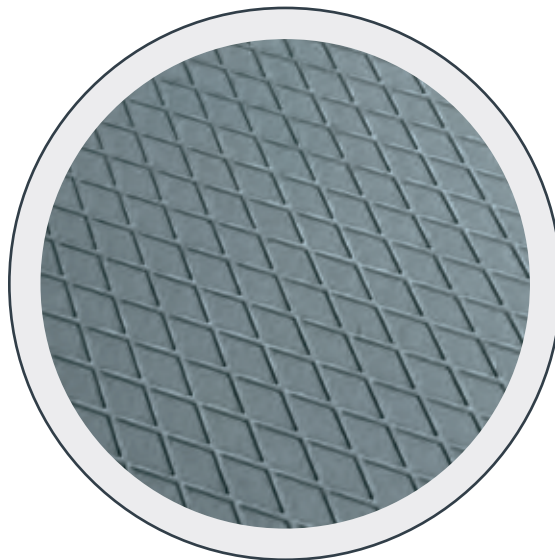

Diamond patterned steel sheets

Chapas estriadas

Product range <i>Gama de producción</i>			
thickness mm	width mm		
	1000	1250	1500
2	•	•	
2,5	•	•	
3	•	•	•
4	•	•	•
5	•	•	•
6	•	•	•
8	•	•	•
10	•	•	•
12	•	•	•

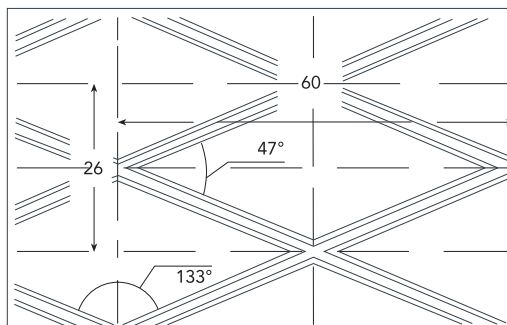

Currently available heights of diamond patterned sheets. The height of the pattern can vary from 1 to 2 mm. *Cotas de la chapa estriada actualmente disponible; la altura de las estrías puede variar de 1 a 2 mm.*

Standard delivery program				
<i>Tabla dimensional del programa de suministro estándar</i>				
thickness mm	commercial sizes mm			average areic mass kg/m ²
	1000x2000	1250x2500	1500x3000	
2	•	•		20,8
2,5	•	•		24,7
3	•	•	•	28,6
4	•	•	•	36,5
5	•	•	•	44,3
6	•	•	•	52,1
7	•	•	•	60,0
8	•	•	•	67,8
10	•	•	•	83,6

Feasible length

Largo factible

200 ÷ 16000 mm

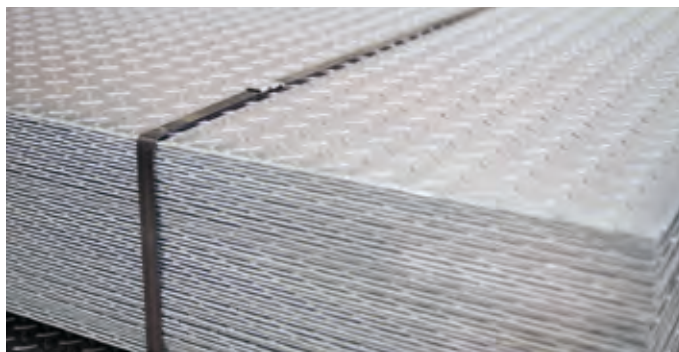

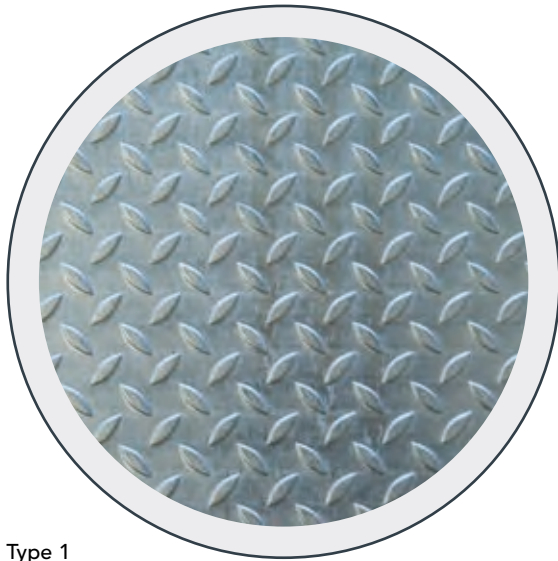

Type 1

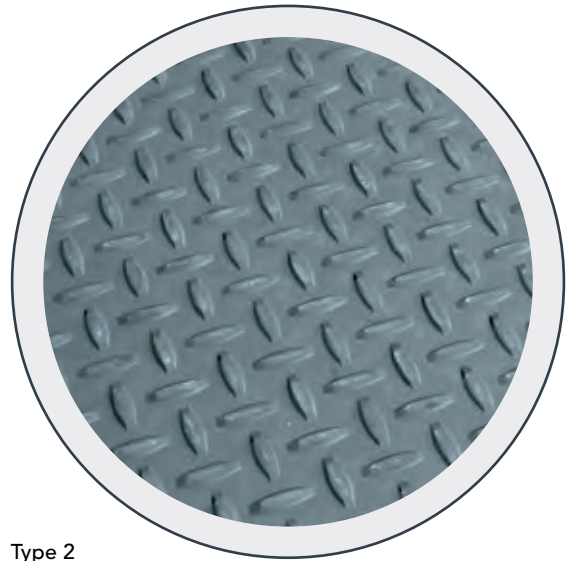

Type 2

Teardrop patterned steel sheets

Chapas lagrimadas

Product range <i>Gama de producción</i>			
thickness mm	width mm		
	1000	1250	1500
2	•	•	
2,5	•	•	
3	•	•	•
4	•	•	•
5	•	•	•
6	•	•	•
8	•	•	•
10	•	•	•
12	•	•	•

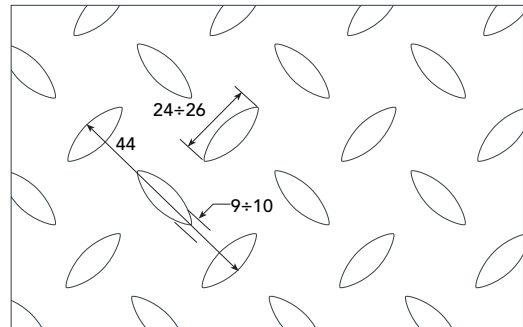

Type 1

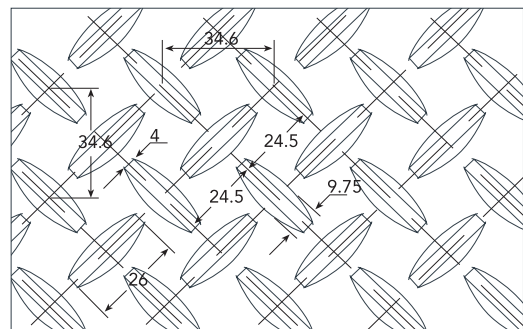

Type 2

Standard delivery program				
Tabla dimensional del programa de suministro estándar				
thickness mm	commercial sizes mm			average areic mass kg/m ²
	1000x2000	1250x2500	1500x3000	
2	•	•		18,20
2,5	•	•	•	22,10
3	•	•	•	26,05
4	•	•	•	33,90
5	•	•	•	41,75
6	•	•	•	49,60
7	•	•	•	57,45
8	•	•	•	65,30
10	•	•	•	81,00

Minimum depth of the indentation 1-2 mm except for the 2.3x1000-1250 formats with a minimum depth of 0.8 mm and the 2x1000-1250, 3x1500 formats with a minimum depth of 0.6 mm.

Altura mínima de la lagrima 1-2 mm excepto para los formatos 2,3x1000-1250 con altura mínima 0,8 mm y para los formatos 2x1000-1250, 3x1500 con altura mínima 0,6 mm.

Feasible length

Largo factible

200 ÷ 16000 mm